

CivE 729
Lecture 4
**Industrial Applications of
Advanced Oxidation Technologies**
Prof. James R. Bolton
and
Prof. Thomas Oppenlaender

Practical Applications

- There are now over 300 commercial UV/oxidation systems installed worldwide treating waste waters at up to 1000 gpm. There is at least one very large system for treating drinking water.
- Catalyzed processes and technology hybrids have dramatically increased the range of application for UV/oxidation.
- Some of the case histories given here are courtesy of Calgon Carbon Corporation (formerly Solarchem Environmental Systems)

**Recent Example of Research and
Development in Reactor Design -
The UV-FSR**

**Institute for Sanitary
Engineering, Water
Quality and Solid Waste
Management,
University of Stuttgart
Prof. Dr. Erwin Thomanetz**



*Ref.: Cutec Serial Publication No. 57, 3rd International
Conference on Oxidation Technologies for Water and
Wastewater Treatment, A. Vogelpohl (ed.), Papierflieger
Verlag, Clausthal-Zellerfeld, Germany, 2003*

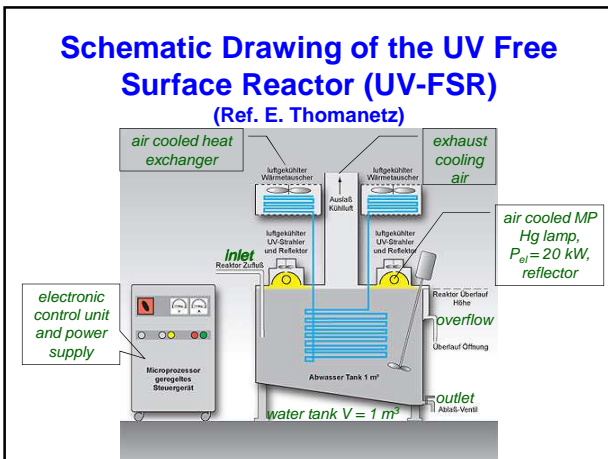

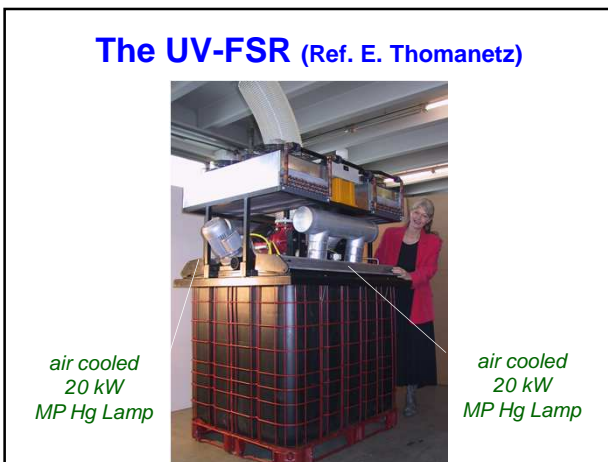

Treatment Examples using the UV-FSR with one 15 kW MP Hg Lamp:
Exploratory Design Experiments
(Ref. E. Thomanetz)

- Real waste water: tar-oil contaminated ground water ▶
- DMSO-glycerol contaminated water ▶

Can UV be used to Treat Micropollutants in Drinking Water?

- Today there is concern about many "micropollutants" in drinking water, such as:
 - pesticides and herbicides ?
 - endocrine-disrupting compounds (EDCs) ?
 - pharmaceutical products (PhPs)
 - N,N-nitrosodimethylamine (NDMA)
- Conventional water treatment technologies cannot treat these micropollutants, with the possible exception of ozone treatment.
- Ultraviolet alone will not work (except for NDMA) because most of these compounds do not absorb UV.

Treatment of Micropollutants

- The novel UV/H₂O₂ process can degrade these micropollutants
- UV is absorbed by added hydrogen peroxide (H₂O₂)



- The hydroxyl radical (•OH) is one of the most powerful oxidizing agents known. It attacks and oxidizes most micropollutants. End products are biodegradable or may go to total mineralization.

Design treatment scheme of the Andijk WTP in North Holland (1968)

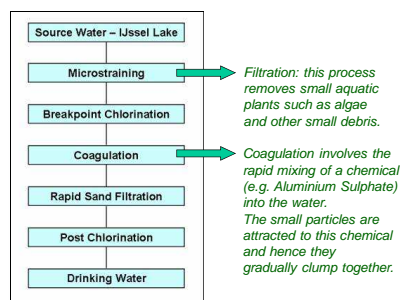

Upgrade Objectives

- Avoidance of the use of chlorine for breakpoint chlorination thereby restricting the by-product (THM) formation;
- Introduction of multiple barriers against pathogenic micro-organisms such as *Giardia* and *Cryptosporidium*;
- Introduction of a disinfection credit for treatment steps based on a 10⁻⁴ health risk;
- Introduction of a general barrier against organic micro-pollutants such as pesticides, endocrine disrupting compounds, algae toxins and pharmaceuticals based on EC and Dutch standards and/or a health risk approach.

Retrofit treatment scheme of the Andijk WTP (1978 – 2004)



Organic Contaminant Control

- In the Netherlands, around 350 pesticides are used with a great variety in persistence, degradability and toxicity.
- Monitoring programs have shown the presence of many of these pesticides in drinking water sources, such as the IJssel Lake.
- Priority pollutants such as atrazine, pyrazon, diuron, bentazone, bromacil, methabenzthiazuron, dicamba, 2,4-D, TCA and triclopyr are found in concentrations up to 1 µg/L.
- For these compounds, the standard of the EC and Dutch drinking water act (0.1 mg/L) must be satisfied.
- In view of the raw water concentrations after storage, the required degradation was set at 80 %.

Endocrine Disrupting Compounds (EDCs)

- In the raw water sources, up to several hundred ng/L were found for bisphenol A, diethylphthalate, diclofenac, ibuprofen, phenazone, carbamazepine and several antibiotics and X-ray contrast media.
- For these compounds, no standards have been set at this moment, but they are of concern.
- The UV/H₂O₂ design targeted all micropollutants, including pesticides, herbicides, pharmaceutical products and EDCs.
- The target reduction level was set to 80% (log reduction = 0.7).

UV/H₂O₂ Treatment of Atrazine in Drinking Water

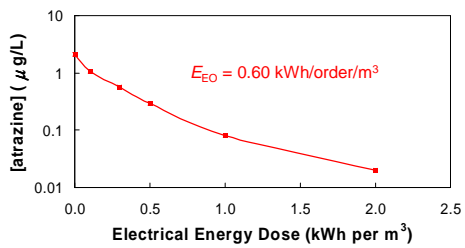

Current treatment scheme at the Andijk WTP (2004 -)

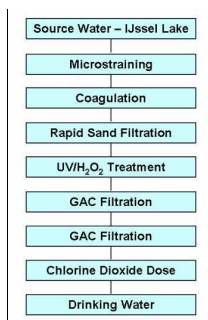

PWN Water Treatment Plant

- Flow rate: 100 mL/d
- UV dose = 560 mJ/cm²
- H₂O₂ dose = 6 mg/L
- 12 large medium pressure UV reactors
- Total Power = 2.4 MW
- Courtesy Trojan Technologies



Treatment of Industrial Wastewater

Rayox UV Reactor

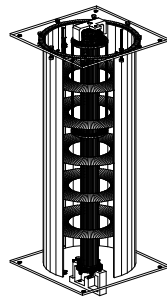

Model 30-3 (90 kW System)

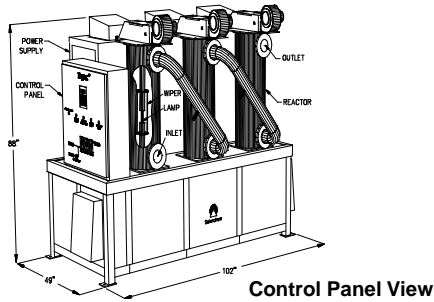

Typical Rayox[®] Operating Costs

Influent Contaminant Load	\$/m ³
≤ 10 mg/L	\$0.08 – \$1.3
10 - 1000 mg/L	\$0.25 – \$13
> 1000 mg/L	\$2.5 – \$25

Selection of UV Oxidation Process

- UV Oxidation process selection is dependent on several water parameters including:
 - transmittance of UV light in subject water
 - volatility of contaminants and their reaction rates with •OH
 - presence of pH dependent •OH scavengers such as carbonate and chloride
 - UV lamp output and reactor design
- UV/H₂O₂ is generally more economic than UV/O₃
- UV/Fentons or UV/Ferrioxalate processes (patented) are more economic than UV/H₂O₂ or UV/O₃ when water has low UV transmittance and chloride interferences are low.

Application Case Histories

- UV/H₂O₂ with GAC Treatment.
- UV/H₂O₂ with Air Stripping for groundwater remediation.
- UV/H₂O₂ with Precipitation/Filtration Pretreatment.
- Iron-catalyzed UV/H₂O₂ treatment of Mixed Wastes.
- Fenton's Process followed by UV/H₂O₂ treatment of high-strength industrial wastewater.

Case Histories

- Ultimately, the selection of a treatment process involves selection of the optimal oxidation process from amongst:
 - Conventional Oxidation: O₃, H₂O₂, O₂, NaOCl
 - Dark Advanced Oxidation: O₃/H₂O₂, Fe²⁺/H₂O₂, O₃/OH⁻
 - UV Advanced Oxidation: UV/H₂O₂, UV/O₃, UV/Fe²⁺/H₂O₂, UV/Ferrioxalate/H₂O₂
- and*
- The combination of technologies, e.g., GAC, air stripping, precipitation/filtration, biodegradation, with UV/Oxidation

Integrated Systems

- Complex mixtures of compounds that are not all amenable to one type of treatment process.
- Target compounds that are readily treated by UV/Oxidation but interferences such as TSS, nitrates or high COD are also present.

Integrated Systems

- High concentrations and stringent effluent quality requirements allow treatment to be divided into a bulk removal step followed by polishing.
- Air quality control regulations require air emission control from an air stripper.

Case #1 - UV/H₂O₂ with GAC

- In some instances, combining UV/H₂O₂ with GAC treatment will result in overall treatment savings, for example:
 - Mixture of poorly adsorbed, easily oxidized contaminants with strongly adsorbed refractory contaminants.
 - Moderately adsorbed contaminants present at high concentrations (>10 ppm) treated by UV/H₂O₂ followed by a GAC polish

Case #1 - UV/H₂O₂ with GAC

- Extending life of GAC by removing easily oxidized contaminants
- Mixture of poorly adsorbed, easily oxidized contaminants with strongly adsorbed refractory contaminants.
- Using GAC as pretreatment to remove UV absorbing water constituent
- Using GAC as a safety net for AOP for concentration and flow fluctuations
- Using GAC for residual H₂O₂ destruction

Case #1 - UV/H₂O₂ with GAC

Mixture of poorly adsorbed contaminants for which AOP is more economical and strongly adsorbed contaminants for which GAC is more economical.

Site Characteristics

- Location: Fort Ord, Monterey, California
- Water Source: Groundwater
- Flow Rate: 710 gpm
- Contaminants: Dichloroethylene (DCE) (strongly adsorbed)
Trichloroethylene (TCE) (strongly adsorbed)
Dichloromethane (DCM) (poorly adsorbed)

Integrated UV/Oxidation/GAC System at Fort Ord

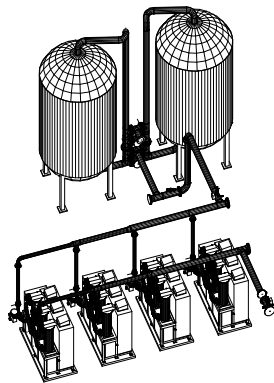

Case #1 - UV/H₂O₂ with GAC

Treatment Performance

	DCE (ppb)	TCE (ppb)	DCM (ppb)
Influent Concentration	21	34	6.9
GAC Effluent	<0.5	<0.5	≈6.9
UV Oxidation Effluent	<0.5	<0.5	<0.5

Benefits of an Integrated Approach

	UV/Ox Alone	GAC Alone	Combination
Controlling Contaminant	DCM	DCM	DCM
Elect. Energy Dose (kWh/1000 gal)	17	---	8.5
Carbon Usage (lb/1000 gal)	---	3.3	0.16
System Size: GAC	---	4 x 10 t	2 x 10 t
UV/Ox	8 x 90 kW	---	4 x 90 kW

Benefits of an Integrated Approach (cont.)

	UV/Ox Alone	GAC Alone	Combination
Capital Cost (\$1000)	970	300	700
Operating Cost (\$/m ³)	\$0.56	\$0.87	\$0.30
Annual Operating Cost (\$1000)	755	1,109	401

Case #2: UV/H₂O₂ with Air Stripping for Groundwater Remediation - New Jersey

In some instances, combining UV/H₂O₂ with Air Stripping will result in overall treatment savings, for example:

1. AOT as pretreatment to air stripper to reduce air discharge.
2. Mixture of low volatility contaminants (AOT) and high volatility contaminants (Air Stripping).

Case #2: UV/H₂O₂ with Air Stripping for Groundwater Remediation - New Jersey

AOT is used as pretreatment to air stripping to reduce total mass of emissions.

Site Characteristics

- Site Location: Millville Municipal Airport, Millville, New Jersey
- Water Source: Groundwater
- Flow Rate: 200 gpm
- Contaminants: Perchloroethylene (PCE), Trichloroethane (TCA), Dichloromethane (DCM)

Case #2: UV/H₂O₂ with Air Stripping for Groundwater Remediation - New Jersey

Treatment Performance

	PCE (ppb)	TCA (ppb)	DCM (ppb)
Influent Concentration	6,000	100	60
UV/H ₂ O ₂ Effluent	10	80	50
Air Stripper Effluent	<1	<1	<1
Mass Removed by Air Stripper	(3.3 lb/day)		

Case #2: UV/H₂O₂ with Air Stripping for Groundwater Remediation - New Jersey

Economics

	UV/H ₂ O ₂ Alone	UV/H ₂ O ₂ Plus Air Stripper
System Size	>3,000 kW	180 kW
UV/H ₂ O ₂ Air Stripper	-	Shallow Tray [®]
Capital Cost	>\$1.0 million	\$325,000
Operating Cost (\$/1000 gal)	\$6.10	\$0.50
Annual Operating Cost	\$2-3 million	\$150,000

**Case History #3 - UV/H₂O₂ with
Precipitation/Filtration Pretreatment**

- In some instances, the pretreatment of a contaminated water by precipitation/filtration will result in overall treatment cost savings, for example:
 - Precipitation of organics that add to COD/TOC to reduce overall demand on UV/H₂O₂ system.
 - Filtration of UV light absorbing water constituents to improve efficiency of UV/H₂O₂ system.

**Case History #3 - UV/H₂O₂ with
Precipitation/Filtration Pretreatment**

Precipitation of organics that add to COD/TOC to reduce overall load on UV/H₂O₂ system.

Site Characteristics

- Site Location: Pine Bluff Arsenal, Pine Bluff, Arkansas, USA
- Water Source: Process wash water, ordinance production equipment
- Volume: 8,000 gal/day
- Requirement: Reduce TOC from ~ 4,000 ppm to less than 15 ppm

**Case History #3 - UV/H₂O₂ with
Precipitation/Filtration Pretreatment**

Integrated System Description

Precipitation: Ferric sulfate as flocculant
pH adjusted to 4.0
Inclined plate clarifier

UV/Oxidation: One 90 kW UV/H₂O₂ batch system
Wastewater is circulated back to a batch tank
Hydrogen peroxide injected in the recirculation loop

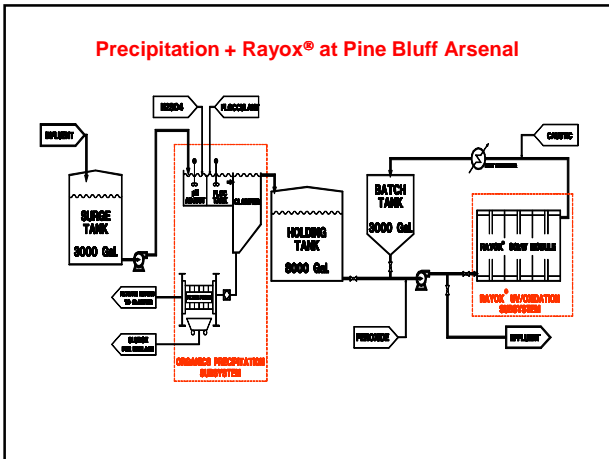

Case History #3 - UV/H₂O₂ with Precipitation/Filtration Pretreatment

Treatment Performance

	TOC (ppm)
Influent Concentration	4,000
Chemical Precipitation Effluent	<700
UV/Oxidation Effluent	15

Case History #3 - UV/H₂O₂ with Precipitation/Filtration Pretreatment

Economics

	UV/Ox Alone	Precipitation + UV/Ox
System Size	7 x 90 kW	1 x 90 kW
Capital Cost (\$1,000)	793	295
Operating Cost (\$/1000 gal)	451	92
Annual Cost (\$1,000)	244	48.3

Case #4: Iron-Catalyzed UV/H₂O₂ Treatment of Mixed Wastes - Argonne

- Nuclear treatment facilities and nuclear power plants build up inventories of organic wastes contaminated with radioactive elements.
- Organic wastes metered into a large amount of water in a mixing tank, 100 mg/L iron (as ferrous sulfate) added and treated by the **Rayox[®]-F** process in a 2000 L batch system with a 30 kW UV reactor.

Rayox[®]-F

- For Waters of:
 - Moderate to high UV Absorbance
 - Moderate to high COD
 - Moderately high pollutant concentration
- Involves the addition of iron (as ferrous sulfate) and lowering the pH to about 3. Hydroxyl radicals are generated by:



Mixed Waste Treatment Results

Compound	Waste Mass (kg)	TOC before polish (mg/L)	TOC after polish (mg/L)	E _{EM} (kWh/kg)	Treatment Cost (\$/kg)
Isopropanol	1	21	0.2	330	59
Toluene	4	27	0.8	193	34
1,4-Dioxane	1	2.1	1.3	303	54
CH ₂ Cl ₂	1		0.3	385	58
1,2,4-Tri-chlorobenzene	1		0.3	303	39
Hexane	1	0.7	<0.2	165	33
Ethylene glycol	1	0.6	0.3	330	55

Mixed Waste UV Treatment Unit

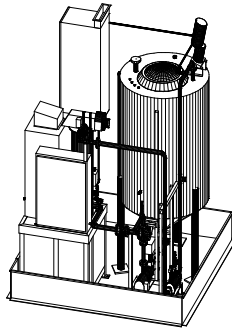

Case #5: Dark Fe/H₂O₂ Followed by UV/H₂O₂ Treatment of High-Concentration Industrial Wastewater - Taiwan

- UV/H₂O₂ will not effectively treat waters with extremely high UV absorbance (e.g., COD > 1000 ppm).
- High concentration wastewaters can be pretreated by Fenton's process (dark Fe/ H₂O₂) to remove the majority of the COD.
- UV/H₂O₂ can then be used as a polish to meet strict COD/TOC or specific pollutant criteria.

Case #5: Dark Fe/H₂O₂ Followed by UV/H₂O₂ Treatment of High-Concentration Industrial Wastewater - Taiwan

- Treatment Objectives:
 - reduce COD in TDI wastewater from 2280 ppm to 100 ppm
 - 20 m³/h
- Treatment costs:
 - \$9.40/m³
 - cost components: H₂O₂, Fe catalyst, power, UV lamps, pH control

Case #5: Dark Fe/H₂O₂ Followed by UV/H₂O₂ Treatment of High-Concentration Industrial Wastewater - Taiwan

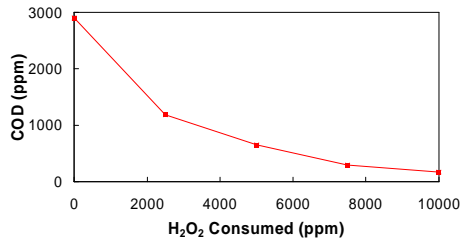

Some Installed Systems

Site	Controlling Contaminant	Flowrate (gpm)	Influent Conc. (ppb)	Effluent Conc. (ppb)
Aberdeen Proving Ground, MD	Thiodiglycol	30	34,000	<10
Mobil Albany	BTEX	100	200,000	<10
Argonne National Laboratory, IL	Laboratory Mixed Waste	1000 gpd	400,000,000	<1
Arvin, CA (EPA)	Dinoseb	2000 gpd	600,000	<100
International Paper	Pentachlorophenol	120	1,000	<10

Some Installed Systems (cont.)

Site	Controlling Contaminant	Flowrate (gpm)	Influent Conc. (ppb)	Effluent Conc. (ppb)
Rohr Aerospace	MEK (Methylethyl ketone)	0.5	35,000,000	<1000
NASA	Hydrazines & NDMA	400 gpd	7,000,000	<1
Norfolk Naval	Phenolics	50	25,000	<100
Pine Bluff Arsenal	Total Organic Carbon	2600 gpd	700,000	<15,000
Kelly AFB	Trichloroethylene	425	4,000	<5

Hyperlinks >>>>

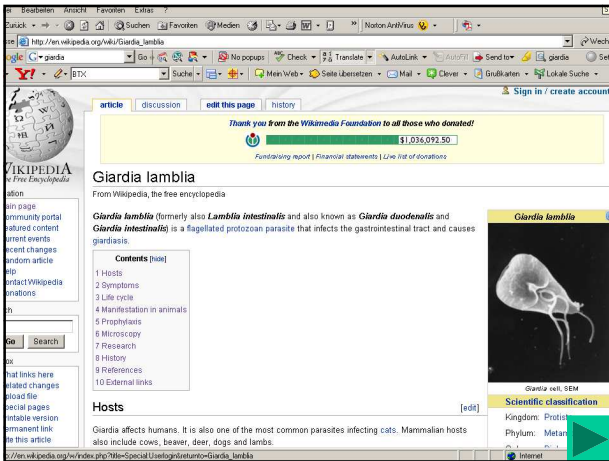



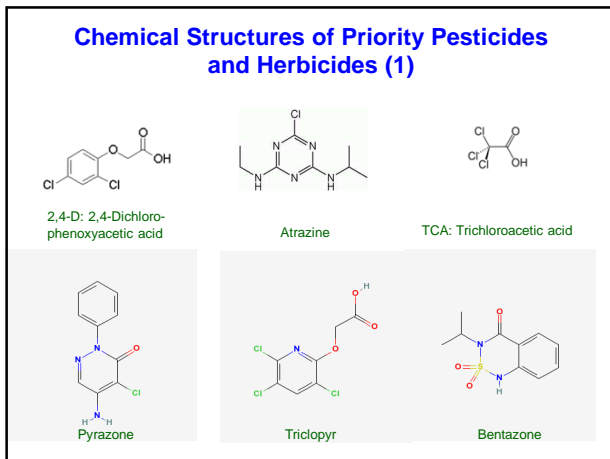

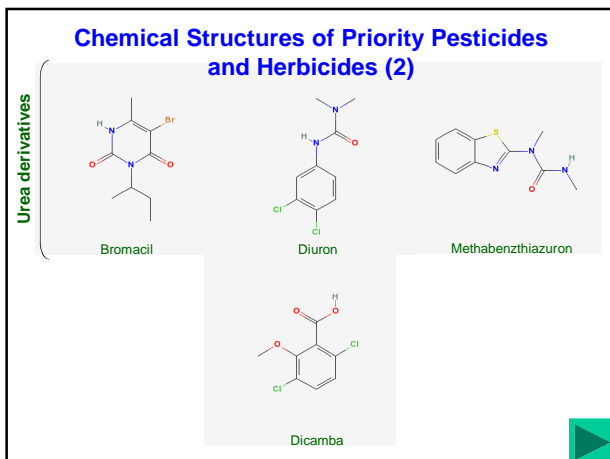

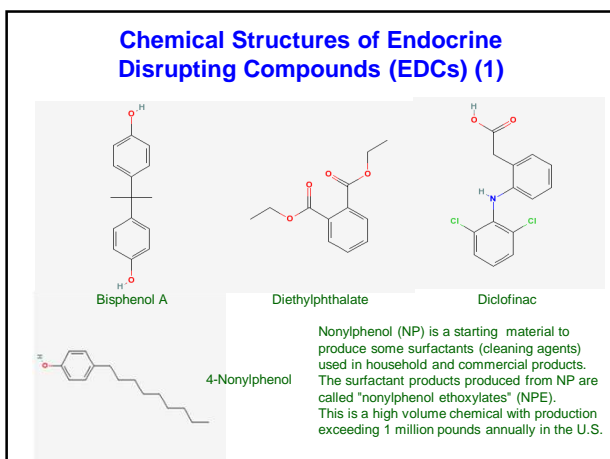

Chemical Structures of Endocrine Disrupting Compounds (EDCs) (2)

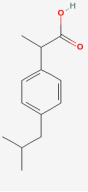

Ibuprofen

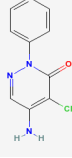

Phenazone

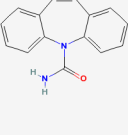

Carbamazepine

Further information:
 Chemical Search Engine: www.neis.com/apps/chemicals
 PAN Pesticide Database: www.pesticideinfo.org/Index.html
 Pesticides US EPA: www.epa.gov/pesticides/

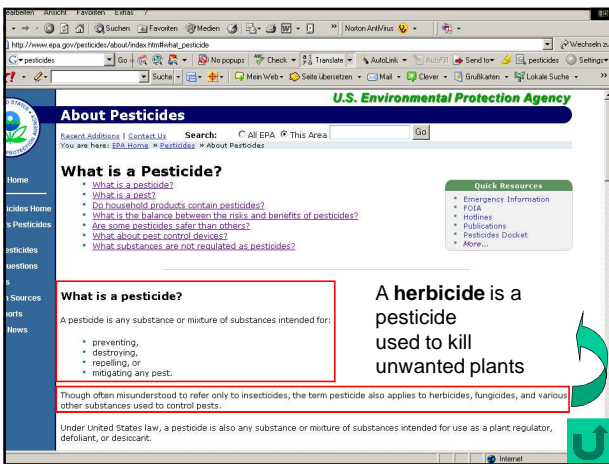

U.S. Environmental Protection Agency
About Pesticides

What is a Pesticide?

A pesticide is any substance or mixture of substances intended for:

- preventing,
- destroying,
- repelling, or
- mitigating any pest.

A herbicide is a pesticide used to kill unwanted plants

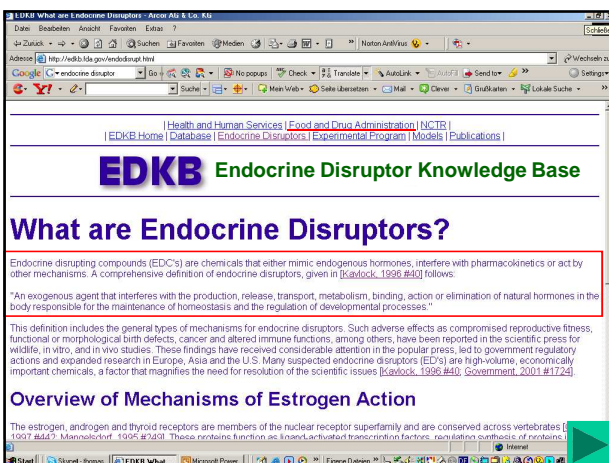

EDKB Endocrine Disruptor Knowledge Base

What are Endocrine Disruptors?

Endocrine disrupting compounds (EDCs) are chemicals that either mimic endogenous hormones, interfere with pharmacokinetics or act by other mechanisms. A comprehensive definition of endocrine disruptors, given in [Gadlock, 1996 #40] follows:

"An exogenous agent that interferes with the production, release, transport, metabolism, binding, action or elimination of natural hormones in the body responsible for the maintenance of homeostasis and the regulation of developmental processes."

Overview of Mechanisms of Estrogen Action
